



# Tank Bag Ring Manual

Please read the manual and related after-sales service terms carefully before use. Incorrect installation and use can damage the product, significantly affect safe driving, and lose related free warranty services.

## Parameter

Model: BTBZJ  
Sub-model: BTBZJ901  
Material: Aluminum alloy, Nylon

## Accessories List

NO.	Name	Diagram	Quantity	Remarks
①	Tank Bag Ring		1 piece	
②	Adapter Base		1 piece	
③	M4*8 Hexagonal Cylinder Head Tapping Screw		4 pieces	Torque: 1.5N·m
④	M5*25 Countersunk Hexagonal Screw		2 pieces	Torque: 3N·m
⑤	M5*50 Countersunk Hexagonal Screw		2 pieces	Torque: 3N·m
⑥	∅8.2*∅5*10mm Aluminum Alloy Washer		4 pieces	
⑦	3mm Hex Wrench		1 piece	
⑧	T25 Hex Wrench		1 piece	
⑨	Screw Glue		1 piece	

## Product Illustration

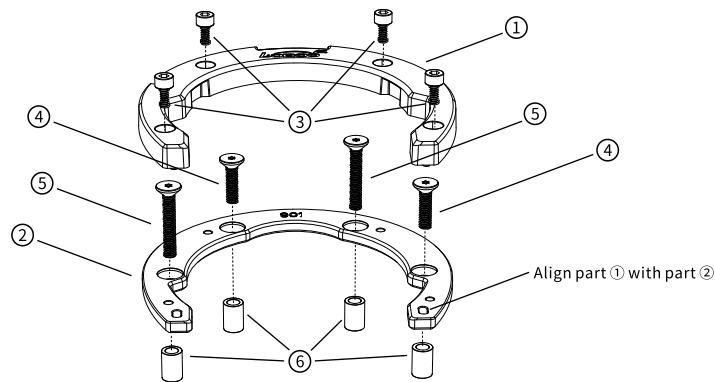

## Tank Bag Ring Manual

1. According to the screw hole position of part ②, remove the corresponding screws on the motorcycle tank cap.

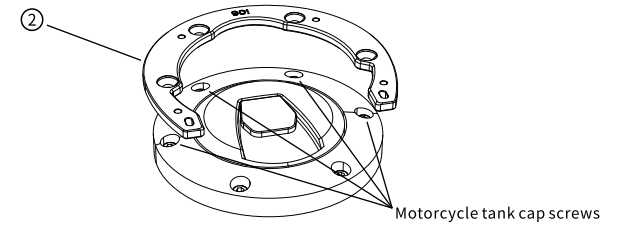

2. Place the aluminum alloy washer on the tank cap screw holes respectively, place part ② on the aluminum alloy washer (note to align the holes), then put in the screws, and tighten the screws in turn. (Torque: 3N·m)

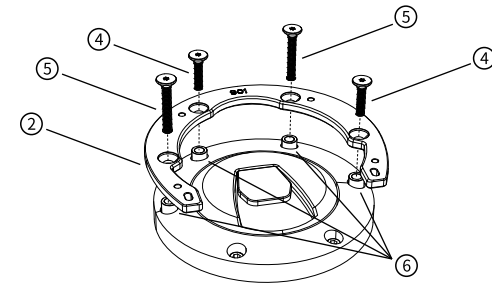

3. Place part ① on top of part ② (note to align the holes), put in the screws, and tighten the screws in turn. (Torque: 1.5N·m)

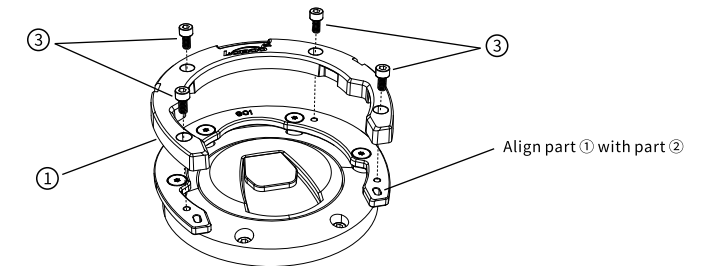

4. Operation completed.

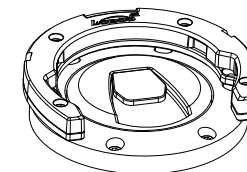

# Warranty Card

Please read this after-sales service guarantee card carefully. If you cannot accept it, please contact the dealer for return and exchange in time. Installation and use means acceptance of this after-sales service term.

## After-sales Service Terms

1. One-year free warranty period, this product can enjoy free repair service within one year from the date of sale if there are quality problems under normal circumstances.
2. Limited warranty: After the one-year warranty period expires, LOBOO will provide paid warranty service, the cost is based on the actual replacement material cost, and no labor cost is charged separately.

## Free Warranty Service Does Not Include The Following

1. No warranty card or cannot provide valid purchase proof.
2. Improper installation, misuse, man-made or accidental damage, self-disassembly, self-modification and repair, etc.

## Return and Exchange Information

Platform ID: \_\_\_\_\_ Order Number: \_\_\_\_\_

Contact Name: \_\_\_\_\_ Contact Phone: \_\_\_\_\_

Return Address: \_\_\_\_\_

## Description

Please keep this card properly and send it back with the product (copy is valid)



## 摩托车通用型油箱包转接底座使用说明

使用前请仔细阅读说明书及相关售后服务条款，错误的安装和使用方式会损坏本产品或对安全行车造成重大影响并失去相关的免费保修服务。

### 产品特性

型号：BTBZJ

款号：BTBZJ901

材质：铝合金、尼龙

### 配件清单

序号	名称	图例	数量	备注
①	油箱盖固定座		1个	
②	转接底座		1个	
③	M4*8内六角圆柱头滚花螺丝		4个	扭力：1.5N·m
④	M5*25沉头内六角花形螺丝		2个	扭力：3N·m
⑤	M5*50沉头内六角花形螺丝		2个	扭力：3N·m
⑥	φ8.2*φ5*10MM铝套		4个	
⑦	3MM内六角扳手		1个	
⑧	T25内六角花形扳手		1个	
⑨	螺丝胶		1支	

### 产品图示

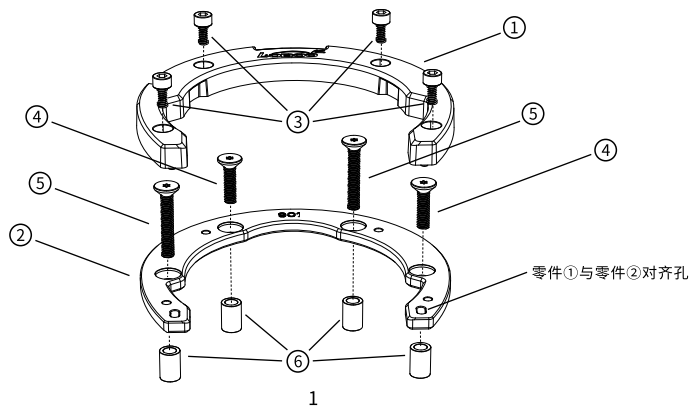

## 摩托车通用型油箱包转接底座安装说明

1. 根据零件②的螺丝孔位，拆除摩托车油箱盖上相应的螺丝。

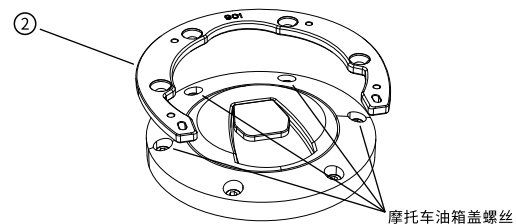

2. 将铝套分别放在油箱盖螺丝孔上，将零件②放置在铝套上（注意将孔位对齐），然后放入螺丝，并依次紧固螺丝。（扭力：3N·m）

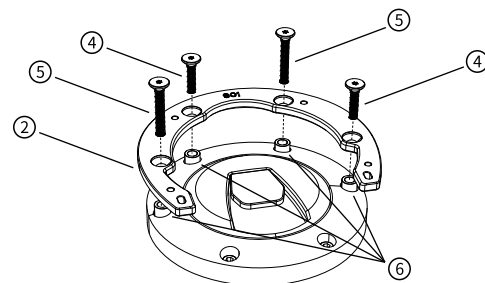

3. 将零件①放置在零件②上方（注意将孔位对齐），放入螺丝，并依次紧固螺丝。（扭力：1.5N·m）

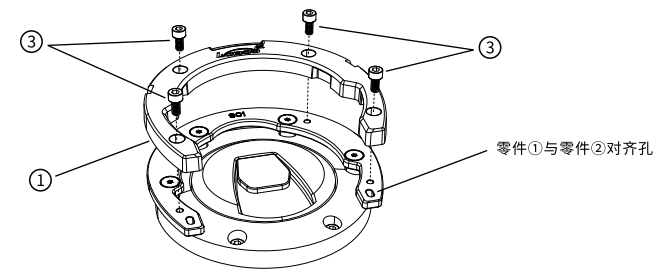

4. 安装完成。

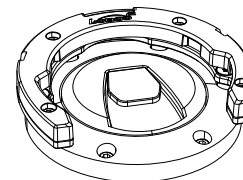

## 售后服务保障卡



请仔细阅读本售后服务保障卡,如不能接受,请及时联系经销商退换货,安装并使用即表示接受此售后服务条款。

### 售后服务条款

1. 1年免费保修期,此款产品自售出之日起1年内,在正常情况下出现质量问题可享受免费维修服务。
2. 有限保修:1年保修时间到期后,LOBOO将提供有偿保修服务,费用以实际更换材料费用为准,不另收取人工费用。

### 免费保修服务不包括以下内容

1. 无保修卡或不能提供有效购买凭证。
2. 安装、使用不当、人为或意外损坏、自行拆解、自行改装和维修等。

### 退换货信息

平台ID: \_\_\_\_\_ 订单编号: \_\_\_\_\_

联系人姓名: \_\_\_\_\_ 联系人电话: \_\_\_\_\_

回寄地址: \_\_\_\_\_

### 售后事项

请妥善保管好此卡并与产品一起寄回(复印件有效)